

SHIFT FORKS & SHIFT TOP PARTS 2000 - 3610 3 CYL

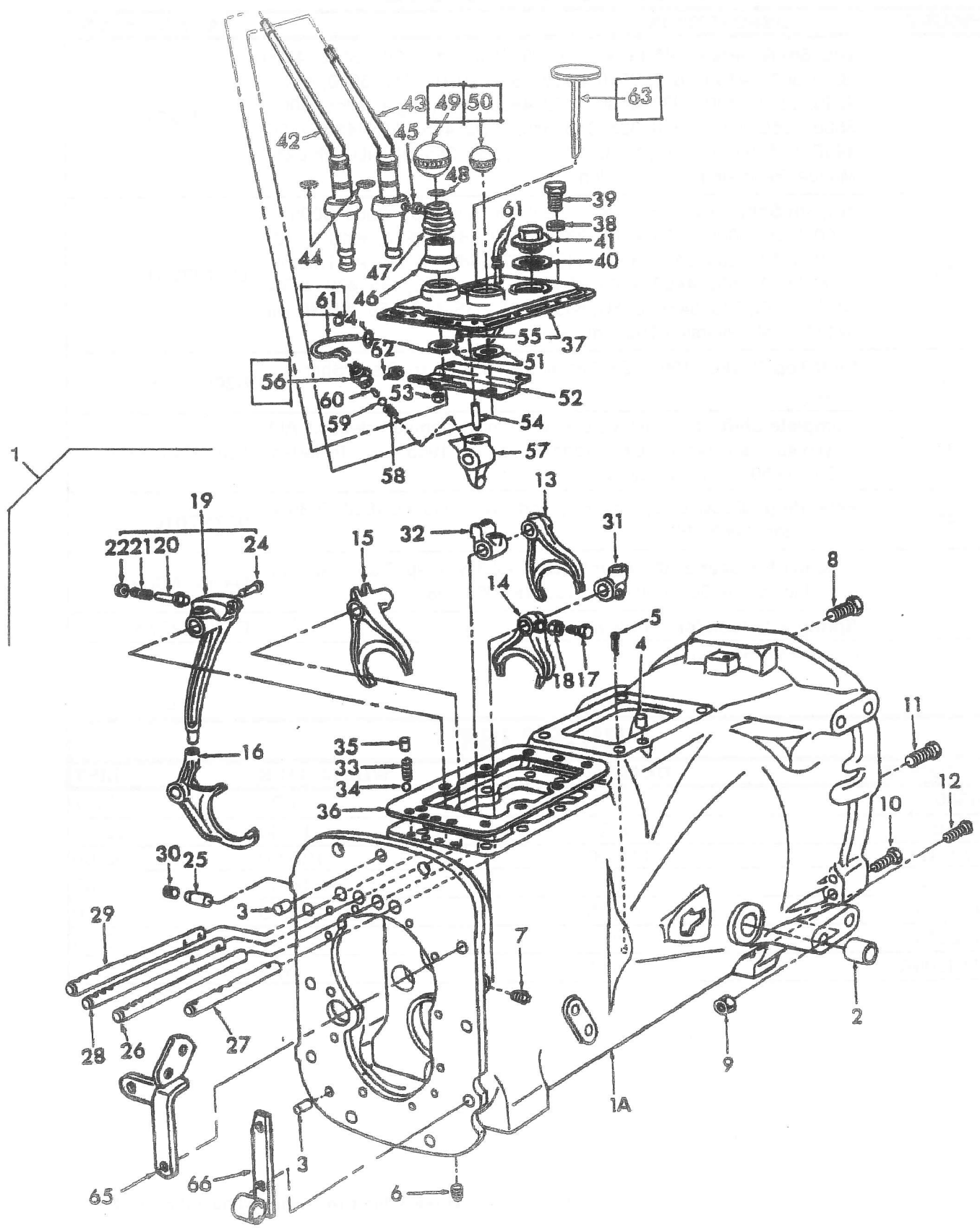

SHIFT FORKS & SHIFT TOP PARTS 2000 - 3610 3 CYL

FIGURE	DESCRIPTION	PART NUMBER
15	2nd, 6th Reverse Shift Fork 1965-98 8 speed 2000, 3000, 4000, 2600, 3600, 4100, 4600, 2310, 2610, 2810, 2910, 3610, 3910, 4110, 4610, 3230, 3430, 3930, 4130, 4630, 4830, 5030, Ag Tractor 3400, 3500, 3550, 4400, 4500, 335, 340, 345, 250C, 445, 420, 445A, 445C, 445D, 545, 545A, 545C, 545D, 515, 535, 550, 555. All IND with 6x4 Manual Reversing Transmission.	C5NN7231S
16	4th, 8th Shift Fork 1965 - 98 1965-98 8 speed 2000, 3000, 4000, 2600, 3600, 4100, 4600, 2310, 2610, 2810, 2910, 3610, 3910, 4110, 4610, 3230, 3430, 3930, 4130, 4630, 4830, 5030, Ag Tractor 3400, 3500, 3550, 4400, 4500, 335, 340, 345, 250C, 445, 420, 445A, 445C, 445D, 545, 545A, 545C, 545D, 515, 535, 550, 555. All IND with 6x4 Manual Reversing Transmission.	C5NN7231E
36	Shift Top Gasket 1965 - 98 Fits all 3 cyl 6 sp, 7 sp, 8 sp, Shift Tops.	82004680
37	Complete Shift Top with levers and filler plug stamped steel fits ALL 3 cyl 6 sp, 7 sp, 8sp and 6X4 Trans Ag and Ind 1965 - 98. Includes 4830 and 5030 4 cyl Tractors	C5NN7211FCT
41	Filler Plug All 3cyl 6 sp, 7 sp, 8 sp and Ind. Includes 4830, 5030 4 cyl Tractors 1965 - 98	957E7010
46	Retainer for Gear Shift Lever Metal All 3cyl 6 sp, 7 sp, 8 sp and Ind. Includes 4830, 5030 4 cyl Tractors 1965 - 98	D4NN7N309A
47	Spring with lock for shift lever	C7NN7227A
49	Large Shift Ball Main Lever All 3cyl 6 sp, 7 sp, 8 sp and Ind. Includes 4830, 5030 4 cyl Tractors 1965 - 98	C5NN7213A
50	Small Shift Ball Hi-Low Range	E440GB9
56	Neutral Safety Switch 1965 - Up For selecto speed, 4 sp and Torque Converter Transmission. Also 6 sp, 7sp and 8 sp. 1965 - 68 with Castiron top fits on top of shift top. Switch has two screws in top.	C7NN7A247B
56	Neutral Safety Switch Fits ALL 3 cyl 6 sp, 7 sp and 8 sp 6X4 Transmission 1968 - up with stamped steel lift top. Switch fits underneath lift top. Has two threaded studs on top of switch.	C7NN7A247A
61	Neutral Safety Wire Assy Fits Neutral Safety Switch C7NN7A247A	D4NN7A488A
63	Transmission Oil Level Indicator Fits ALL 3 cyl Shift tops 1965 - 98 Less Cab	E1NN7A020BA
Not Shown	Weld in Repair Retainer for stamped steel shift top	ALX2A3000
Not Shown	Rubber Dust Cover For Shift lever	C5NN7277D
Not Shown	Complete Transmissiion Gasket Kit Fits All 3 cyl, 6 sp, 8 sp, 6X4 1965 - Up	TGK3600